

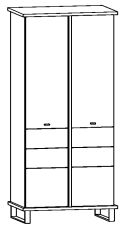











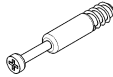



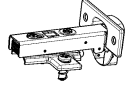

# CRO-21 Szafa 2D

L-90 H-195 D-60

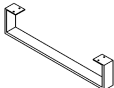

60 min

<b>x 20</b>  AKC00019	<b>x 6</b>  AKC00056	<b>x 6</b>  AKC00004	<b>x 14</b>  AKC00029	<b>x 12</b>  AKC00151	<b>x 2</b>  AKC00152
<b>x 14</b>  AKC00004	<b>x 6</b>  ZAW00025	<b>x 16</b>  AKC00023	<b>x 4</b>  RUR00002	<b>x 60</b>  AKC00018	<b>x 2</b>  UCH00056
<b>x 28</b>  3,5x16 AKC00026	<b>x 36</b>  3,5x30 AKC00026	<b>x 4</b>  4x25 AKC00026	<b>x 1</b>  AKC00017	<b>x 2</b>  HDF	<b>x 2</b> L-394 mm  RUR00001
<b>x 2</b>  NOG00045					

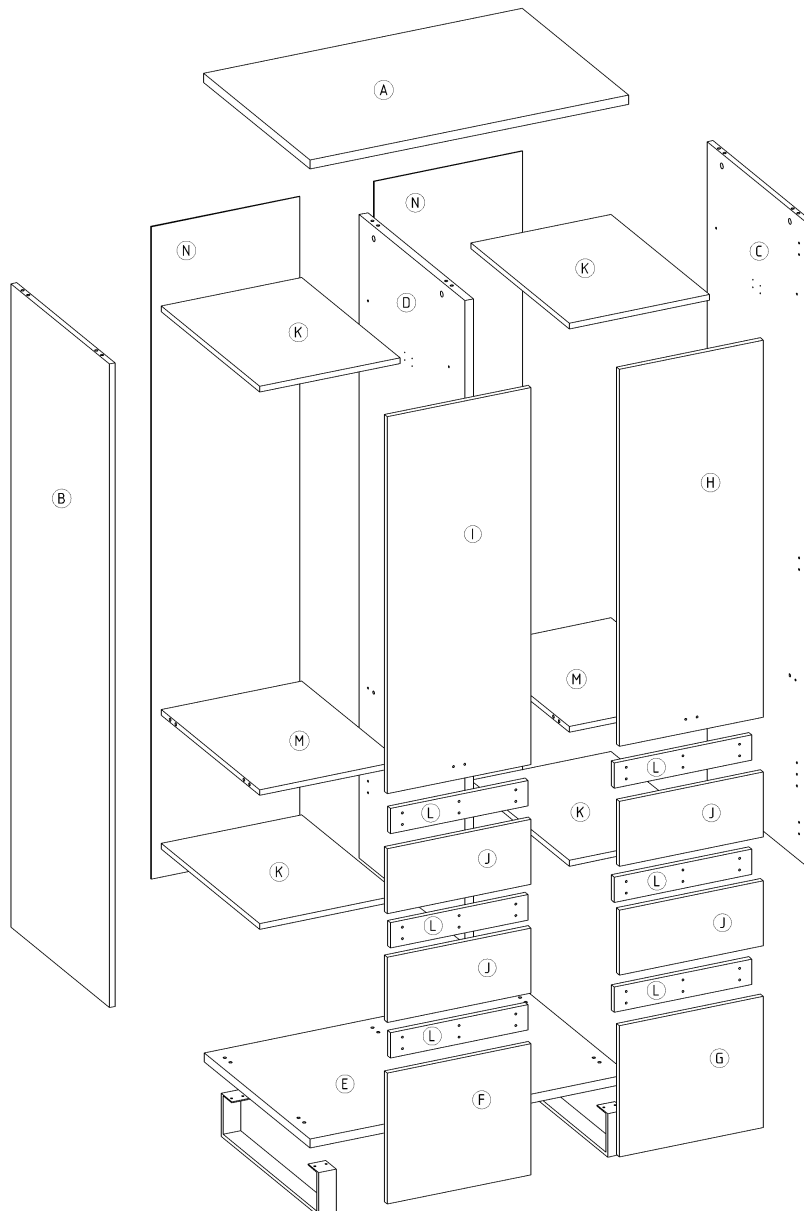

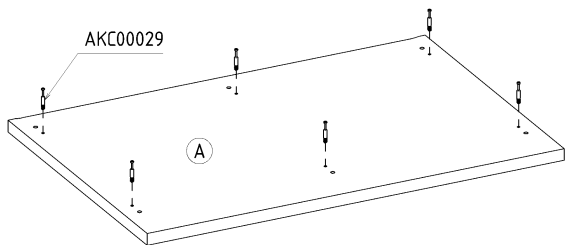
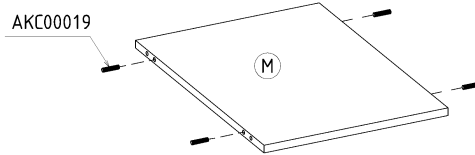
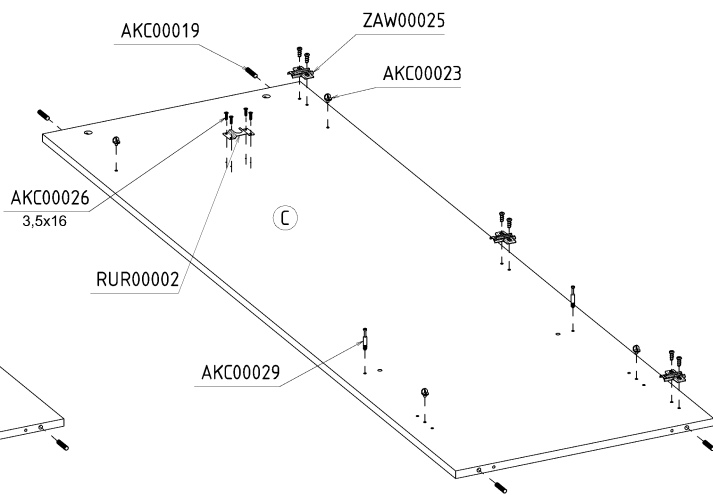
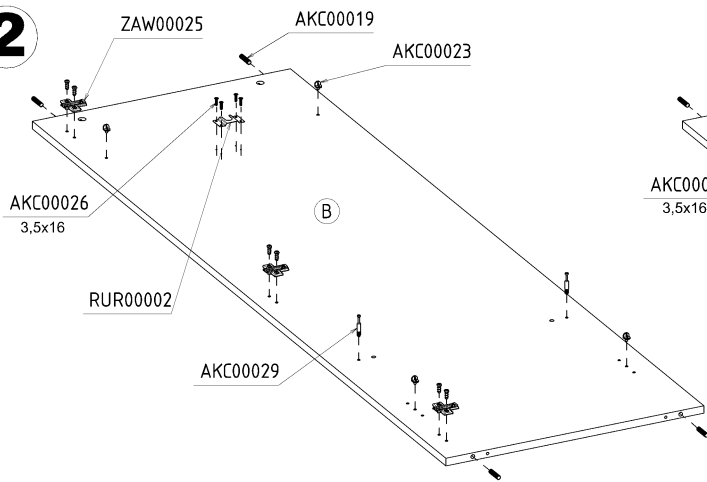
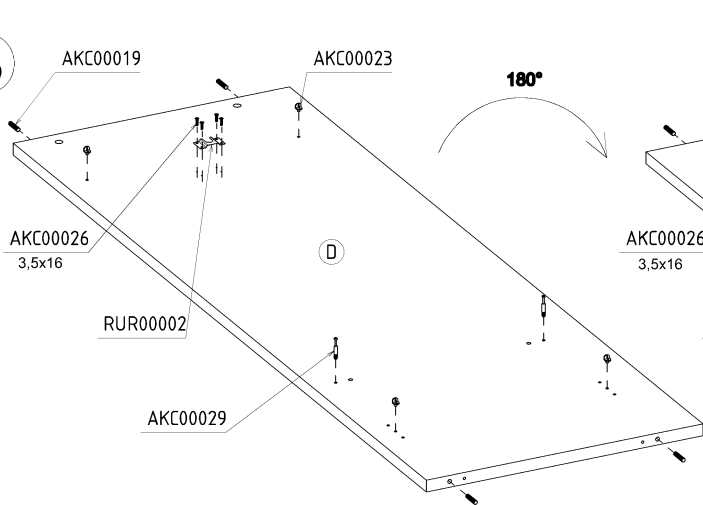
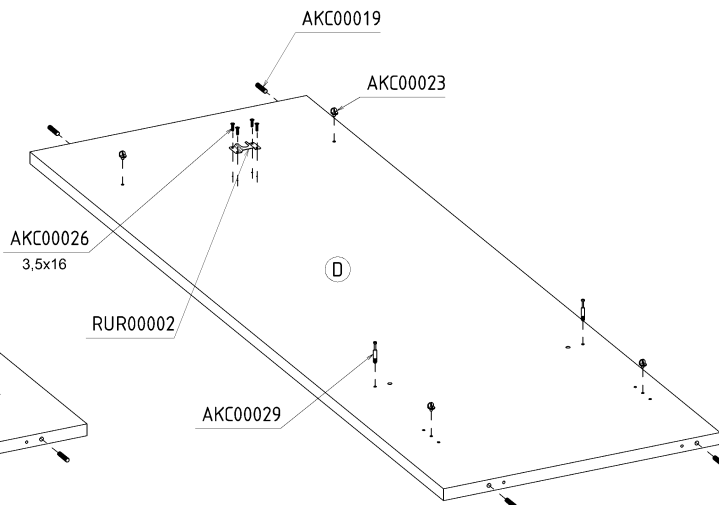
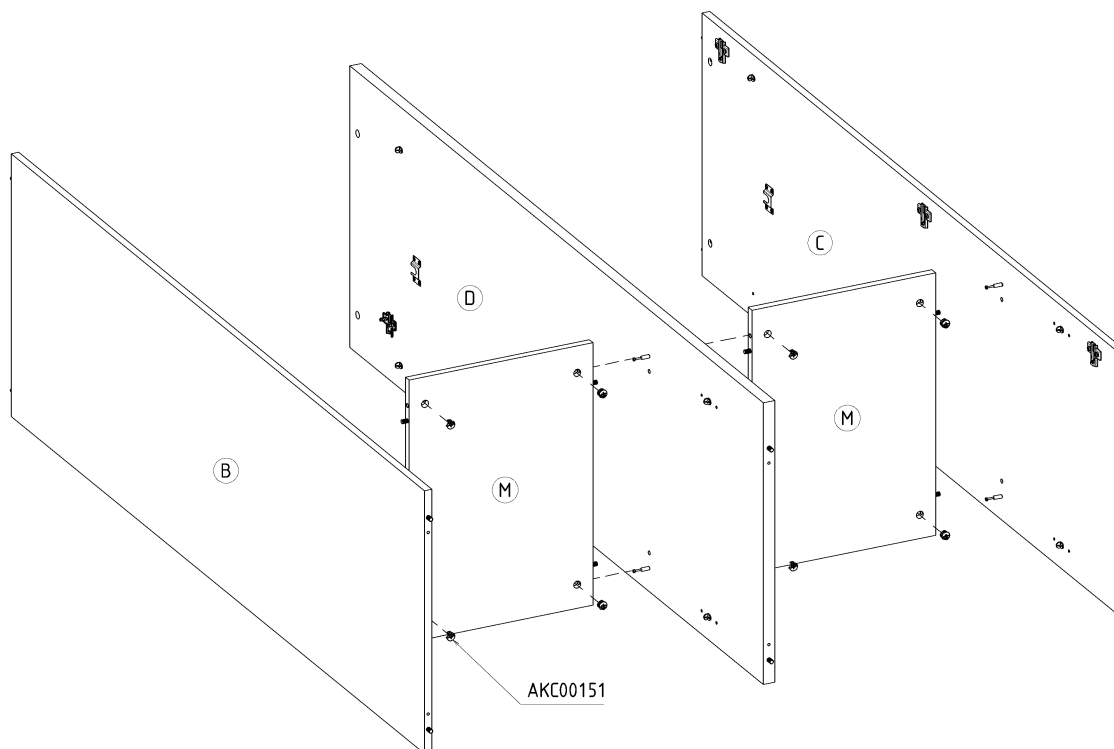
**1****x 2****2****3****180°****4**

5

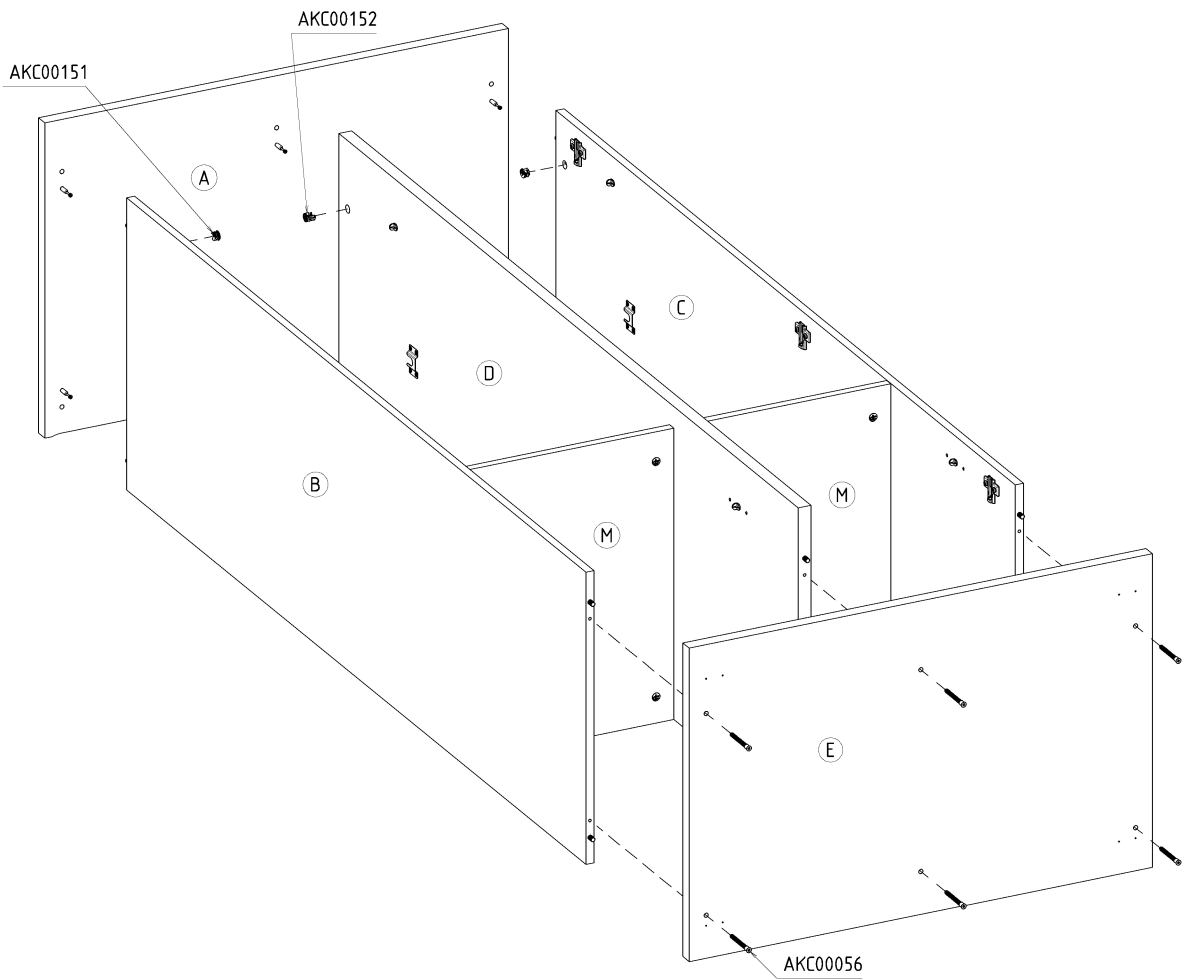

6

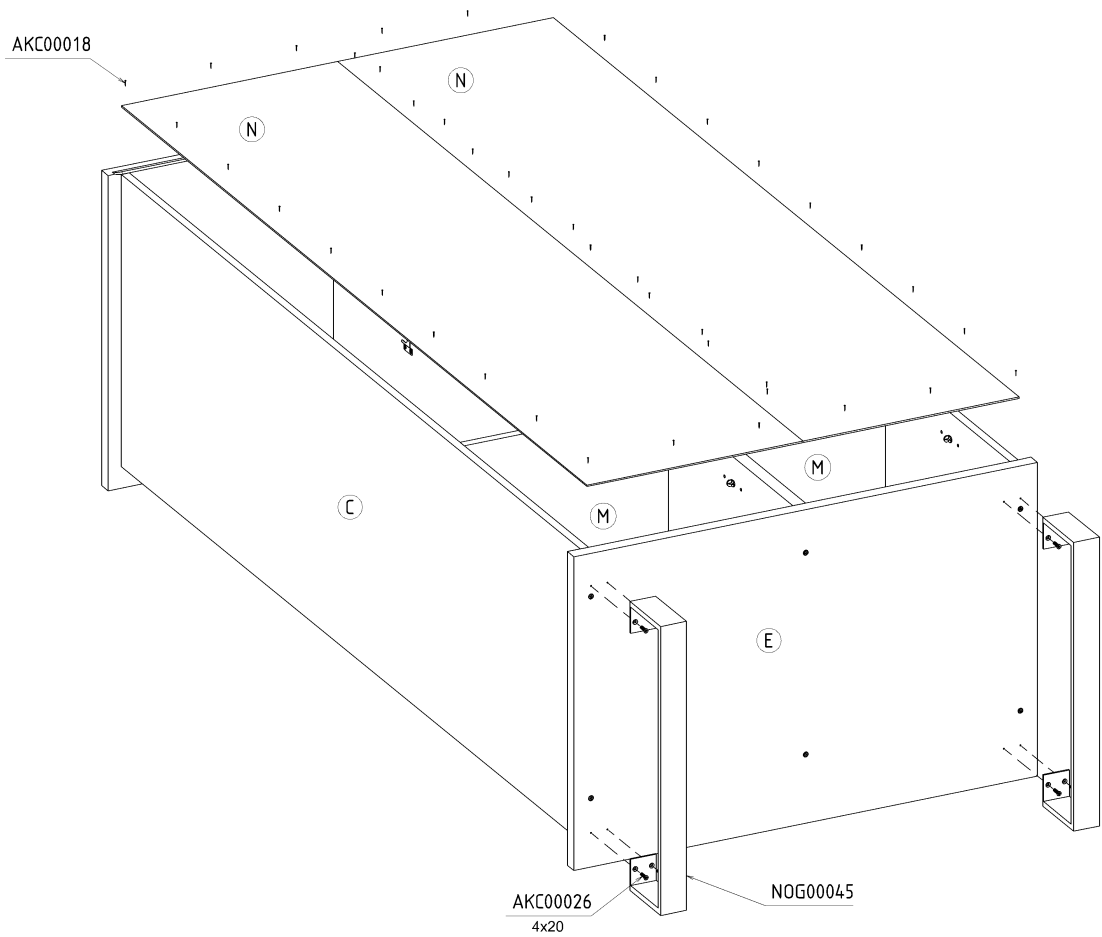

7

AKC00026  
3,5x16

ZAW00025

AKC00026  
3,5x16

ZAW00025

H

I

AKC00026  
3,5x30

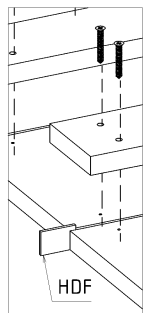

AKC00026  
3,5x30

HDF

F

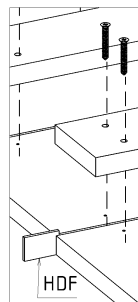

HDF

G

8

RUR00001

A

RUR00001

K  
MAX  
5 kg

K  
MAX  
5 kg

B

C

UCH00056

H

UCH00056

D

M  
MAX  
5 kg

M  
MAX  
5 kg

AKC00026  
4x25

J

AKC00026  
4x25

J

J

J

J

F

K  
MAX  
5 kg

K  
MAX  
5 kg

J

J

J

J

J

J

G

E